



KOBELCO

Flux Cored Wires

**High quality and high efficiency
welding in every field**

KOBELCO WELDING OF AMERICA, INC.

KOBELCO WELDING OF AMERICA INC.

Kobelco Welding of America Inc., (KWAI) was established in Houston, Texas in 1990, as a wholesale company owned by Kobe Steel USA Holdings for marketing Kobelco welding consumables in North America and Latin America.

Since KWAI launched its business, it has worked closely with all its customers through quality services both in sales activities and technical support. Because of its outstanding business attitude, KWAI has earned rapid growth led by its excellent reputation and the distributor's sales network expansion nationwide. Today, more than 300 distributors are stocking Kobelco welding wires, mostly flux-cored wires, supplied from KWAI. In particular, KWAI's stainless steel flux cored wires have earned the largest market share, 40%, in the North American market.

KWAI will pursue customer satisfaction, through the activities based on the business slogan QTQ (Quality products, Technical support and Quick delivery), targeting a higher market share. KWAI expanded its sales network by opening the Cincinnati Distribution Center (1996), the Chicago Distribution Center (1999), the Salt Lake City Distribution Center (2002) and the Birmingham Distribution Center (2006).



Strength and selling features of Kobelco's FCW



Quality

1. Optimum flux design, low fume/ low spatter, easy to weld.
2. All spool products are precision-layered wound to insure smooth feeding.
3. Non-baked method of manufacturing leaves clean finish with no scale or oxidation on wire surface which leads to superior feeding and arc stability as well as less wear on tips liners.
4. Consistency of quality in products.

Technical Support

1. Superior technical support
2. Continued development for future high quality products
3. Every lot number has actual weld tests at no charge

According to EN 10204 Type 3.1

INSPECTION CERTIFICATE (Left):
 PURCHASER: _____
 FLUX CORED WIRE
 TRADE DESIGNATION: FRONTARC-711
 DIMENSION: 0.045 inch
 WIRE No.: F.4A040
 APPLICABLE SPECIFICATION: AWS A5.20 E71T-1C/N/A48 AWS
 CHEMICAL COMPOSITION (%): C: 0.04, Si: 0.45, Mn: 1.21, P: 0.011, S: 0.006, Cu: 0.02, Ni: 0.01, Cr: 0.01, Nb: 0.02
 DEPOSITED METAL: _____
 MECHANICAL PROPERTY: YIELD POINT (at 0.2% OFFSET): 70 ksi, TENSILE STRENGTH: 63 ksi, ELONGATION: 30%, TEST TEMP: 20°C, ABSORBED ENERGY: 55 J, IMPACT TEST: 15 J, 52 J, 30 J

INSPECTION CERTIFICATE (Right):
 PURCHASER: _____
 FLUX CORED WIRE
 TRADE DESIGNATION: DW-308LP
 DIMENSION: 0.065 inch
 WIRE No.: F.31.2155
 APPLICABLE SPECIFICATION AND CLASSIFICATION: AWS A5.22 E308LT1-1 AWS A5.22 E308LT1-4 ASME SFA-5.22 E308LT1-1 ASME SFA-5.22 E308LT1-4
 CHEMICAL COMPOSITION (%): C: 0.02, Si: 0.50, Mn: 1.46, P: 0.020, S: 0.003, Cu: 0.02, Ni: 10.10, Cr: 18.47, Nb: 0.01, Ti: 0.01, Fe: 0.020, N: 0.002, O: 0.002
 DEPOSITED METAL: _____
 MECHANICAL PROPERTY: YIELD POINT (at 0.2% OFFSET): 77 ksi, TENSILE STRENGTH: 45 ksi, ELONGATION: 45%, TEST TEMP: 20°C, ABSORBED ENERGY: 70 J, IMPACT TEST: 15 J, 52 J, 30 J

Quick delivery

1. Reliability in delivery
2. A large stock in USA Kobelco warehouse (6 locations)
 Stafford, TX, Cincinnati, OH, Salt Lake City, UT,
 Chicago, IL, Philadelphia, PA, Birmingham, AL

High efficiency and low costs

Welding efficiency consists of both deposition rate and deposition efficiency. The deposition rate is the amount of weld metal which is deposited on the base metal in certain time. Higher deposition rate enables faster welding and thus realize a reduction of the unit labor cost. Flux cored wire has much higher deposition rate than covered electrode or solid wire as can be seen in Figure 1.

Deposition efficiency is the ratio of deposited metal weight to the weight of filler metal consumed. Higher deposition efficiency reduces the amount of wire necessary for welding and the cleaning work. Figure 2 shows the comparison of welding costs between a FCAW, GMAW and SMAW. As shown in this figure, Kobelco FCW has the economic advantages.

When compared to using covered electrode or solid wire, Kobelco FCW can be welded in much faster speed especially in the application for vertical up and overhead welding. This is mainly due to the fact that spray arc occurs at around 150 amperes for 0.045 inch diameter rutile flux cored wires and higher amperage can be applied in all positions.

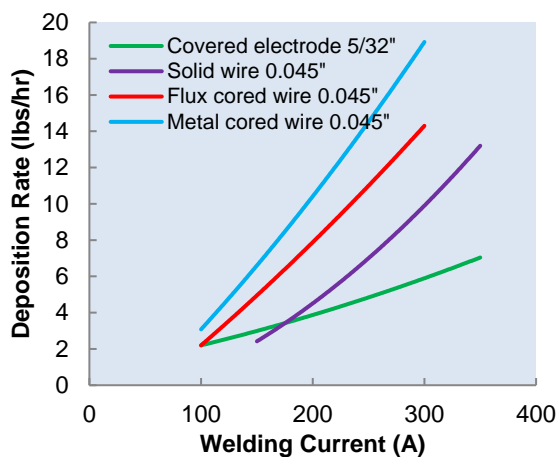

Fig.1 Deposition rates for different consumables

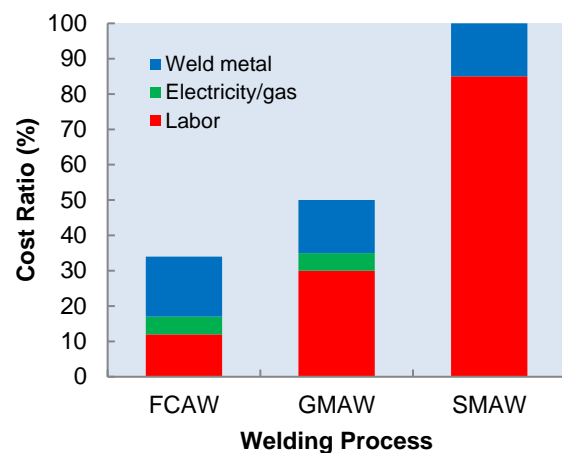

Fig.2 Welding cost in vertical upward position

Welding with Kobelco Flux Cored Wires

To obtain high quality welded structures conforming to specifications and the purpose of design, welding work must be carried out in accordance with safe procedures for manufacturing. Before the actual welding starts, the applied shielding gas, parameters and welding method must be determined. Also the welding environment sometimes requires preventative measures.

Shielding gases

A shielding gas is necessary for protecting the molten pool from the adverse effects of nitrogen and oxygen from the surrounding air. The proper gas composition is important for the bead appearance, weldability and the mechanical properties of the weld metal.

Welding parameters

The adjustment of the appropriate welding current and voltage are very important. Welding current and voltage influence the arc stability, bead appearance, undercut, penetration, spatter, etc. A proper welding current depends on type and size of wire and welding position. Figure 3 shows applicable range for welding parameters. As can be seen in Figure 4, deposition rate is influenced by welding current and wire diameter. The arc voltage must be kept constant during welding operation. Increased arc voltage can affect the weld soundness. Suitable voltage depends on the type of wire being used.

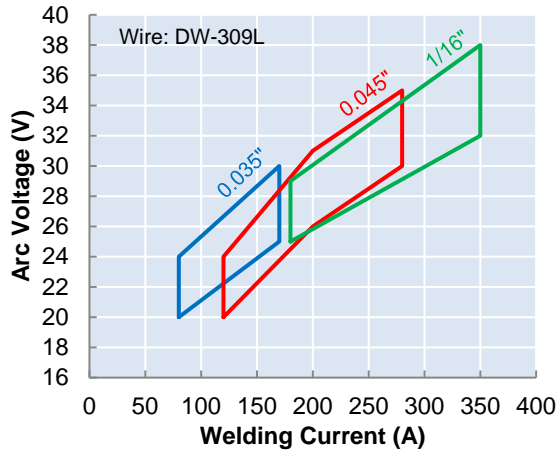

Fig.3 Applicable range for welding parameters

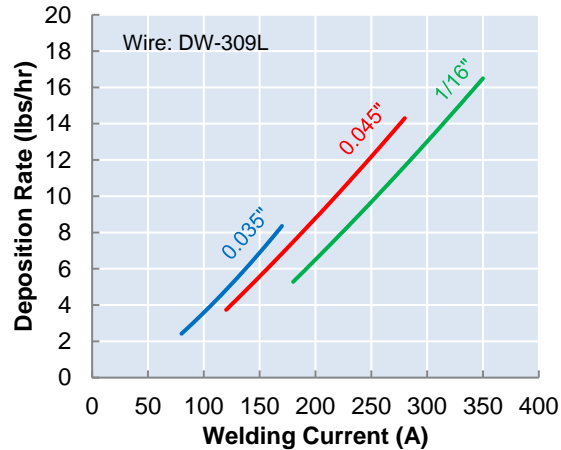

Fig.4 Deposition rates for different diameters

Electrode Extension and deposition rate

Contact Tip to Work Distance (CTWD: Figure 5) influences stability, penetration, bead appearance and deposition rate.

Deposition rate can be increased by welding with a longer CTWD. This is achieved by the resistance heating in the wire. The wall thickness of Kobelco FCW is quite thin, thus its cross sectional area is small, resulting in a high current density in the wire. The higher current density increases the melting rate of the wire, resulting in a higher deposition rate. Figure 6 shows this effect of CTWD to deposition rate.

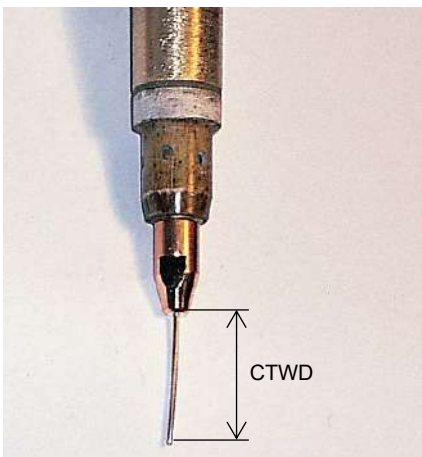

Fig.5 Contact tip to work distance

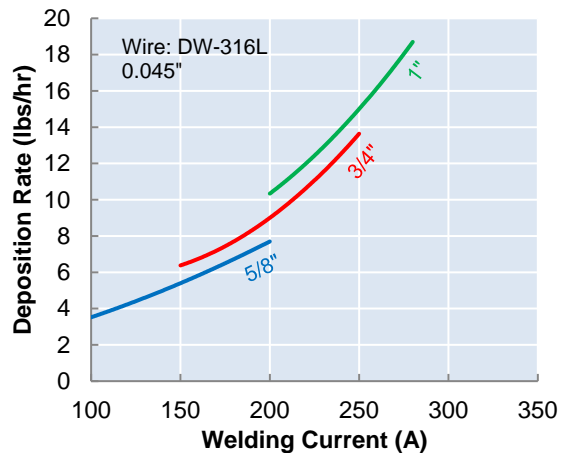

Fig.6 The effect of CTWD on deposition rate

Preheat and interpass temperature

In order to prevent problems, preheating and interpass temperature may have to be controlled depending on the type of FCW, the type and thickness of base material and the ambient temperature.

Heat input

In order to reach the desired impact value, the heat input may have to be controlled depending on the type of FCW and the type and thickness of the base material.

Welding speed

Welding speed governs weld penetration, weld bead appearance, porosity susceptibility and the leg length and throat thickness of the weld bead.

Welding technique and torch angle

Gas shielded arc welding allows for both forehand and backhand welding. For welding mild steel FCW, forehand welding is mostly preferred during horizontal fillet welding and cap pass welding. Although it offers shallower penetration it achieves flatter weld bead surfaces. Backhand welding is better for welding inside a groove. Beads are more convex but this technique has the benefit of deeper penetration.

For welding stainless FCW, backhand welding brings the best results, with good penetration and a flat weld bead. As the torch angle becomes too large, forehand welding with stainless FCW is not preferred as it tends to generate spatter.

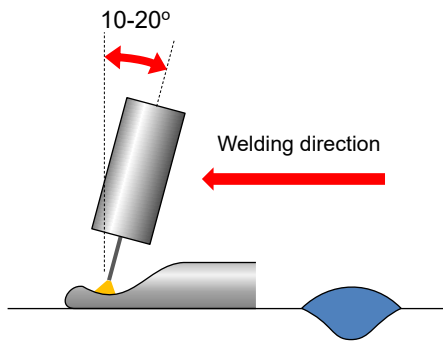

Fig.7 Forehand welding

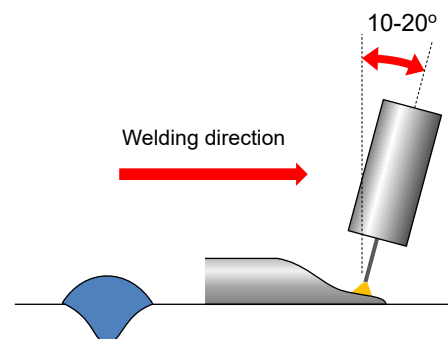
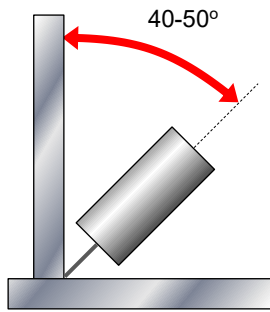

Fig.8 Backhand welding

Figure 9-11 show correct torch angles for horizontal fillets with the torch perpendicular to the welding direction. The torch angle is dependent on the kind of pass sequence to be applied. More passes will result in larger throat thickness and leg lengths. The leg length may be controlled by the welding speed or the amperes, voltage and electrode extension being applied.



Leg length <0.2"

Fig.9 Single pass fillet welding

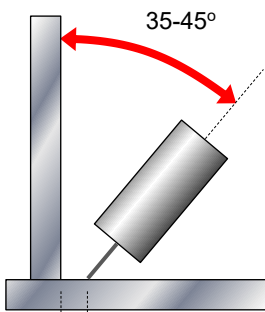

Leg length >0.2"

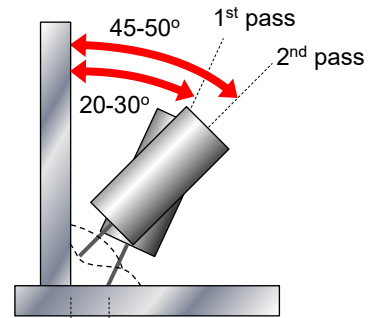

Leg length 5/16-1/2"

Fig.10 Two pass fillet welding

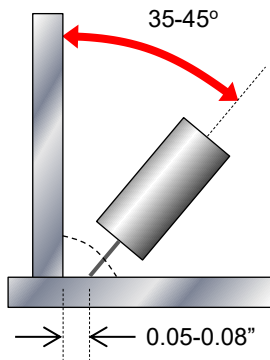

0.05-0.08"

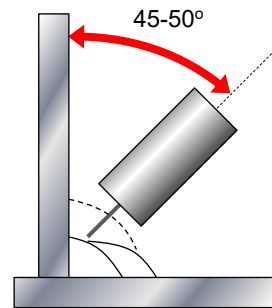
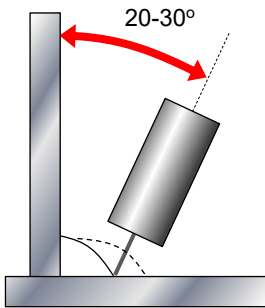

Fig.11 Multi pass welding of a leg length of 1/2" or more

Protection in welding

Welders should wear suitable protective clothing and eye protection during welding operations. Ventilation and/or fume extraction must be sufficient so as to keep fume concentrations within safe limits.

Guideline of consumption of wire

Butt welding: Root gap=0"

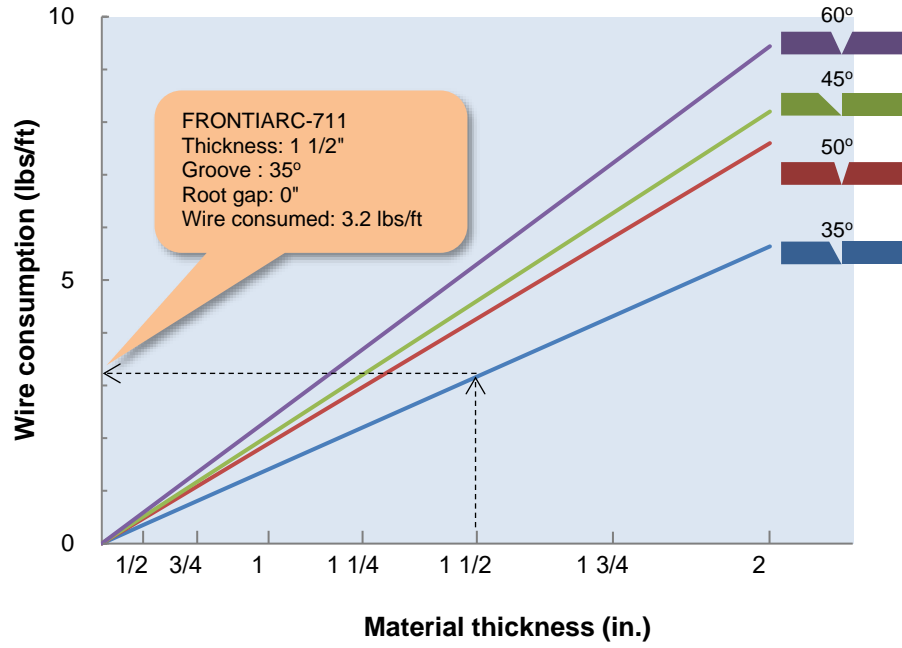

Butt welding: Root gap=1/4"

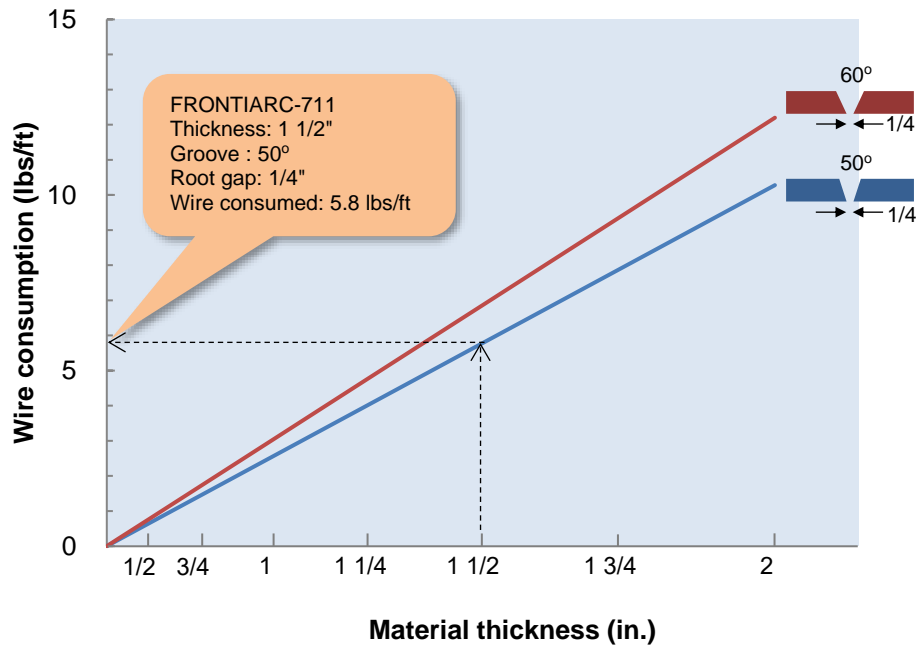

Fillet welding

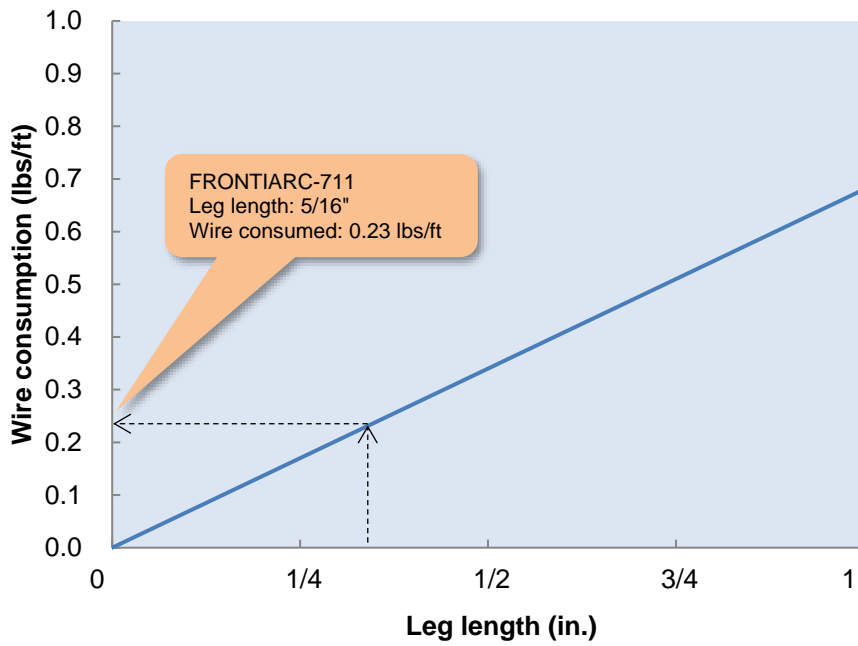

Unit length of welding wire (feet of wire/lb)

Products	Wire diameter (inch)			
	0.035	0.045	0.052	1/16
Flux cored wire (FRONTIARC-711)	-	201	148	113
Metal cored wire (MX-A70C6LF)	-	192	139	106
Solid wire (MG-51T)	301	168	-	-
Flux cored wire (DW-308LP)	374	199	-	114

Dimension of spool, coil and drum (inch)

			FCW	Solid
Spool	28 lbs	A	11.02	-
		B	4.06	-
		C	2.05	-
Spool	44 lbs	A	11.02	10.63
		B	4.06	4.06
		C	2.05	2.05
Coil	50 lbs	D	15.75	-
		E	4.33	-
		F	12.21	-
Drum	550 lbs	G	20.07	20.07
	660 lbs	H	32.28	32.28

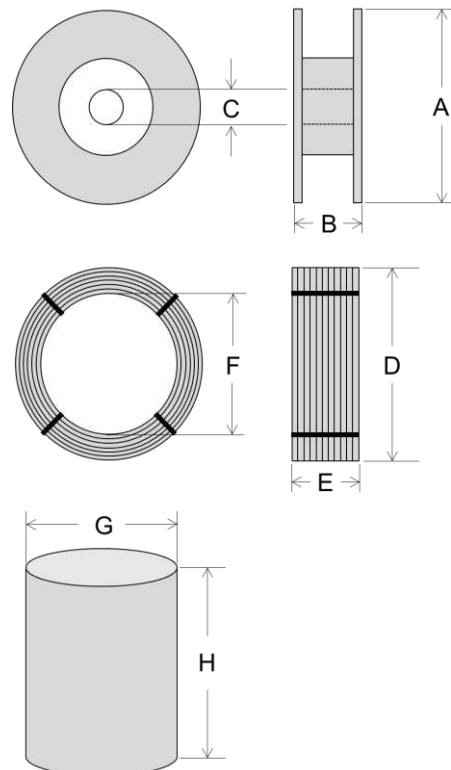

Stainless Steel Flux Cored Wire (DW Series)

Recommended Welding Parameters (Shielding gas: 100% CO₂)

Wire Diameter (in.)	Wire Feed Speed (in./min.)	Welding Current (A)	Arc Voltage (V)	Deposition Rate (lbs/hr)	CTWD (in.)	Shielding Gas Flow Rate (CFH)
0.035	180	80	23-25	2.2	1/2	35-45
	205	90	23-25	2.5		
	250	100	24-26	3.0		
	280	110	25-27	3.3		
	330	120	26-28	3.9		
	375	130	27-29	4.5		
	460	140	28-30	5.5		
	550	150	29-31	6.6		
0.045	210	140	24-26	5.0	5/8-3/4	40-50
	275	160	25-27	6.0		
	330	180	26-28	6.7		
	380	200	27-29	8.0		
	440	220	28-30	9.3		
	545	240	29-31	10.6		
	615	260	30-33	12.0		
	680	280	31-33	13.5		
	780	300	31-33	15.0		
1/16	155	200	28-30	6.5	3/4-1	40-50
	195	220	29-31	8.0		
	230	240	30-32	8.5		
	260	260	31-33	9.3		
	290	280	31-33	11.0		
	330	300	31-34	12.0		
	360	320	32-35	13.5		
	420	350	33-35	16.0		

Table shown is approximate values that will vary with change in welding conditions. DC-Electrode positive.
For 75% Ar + 25% CO₂, two (2) volts lower than shown.

Features

1. Compared with covered electrode (SMAW)

High efficiency, High deposition rate, Less spattering, Good bead appearance, and Good slag removability

2. Compared with TIG rod (GTAW)

High deposition rate

3. Compared with MIG wire (GMAW)

Less voltage sensitive, Less spattering, Good bead appearance (No oxidized surface), Easy to make multi-pass, Higher deposition rate, and Lower gas cost

Stainless Steel Flux Cored Wire (DW-G Series) -

- For gauge materials -

Recommended Welding Parameters (Shielding gas: 100% CO₂)

Wire Diameter (in.)	Wire Feed Speed (in./min.)	Welding Current (A)	Arc Voltage (V)	CTWD (in.)	Shielding Gas Flow Rate (CFH)
0.045	140	85	18-21	1/2	35-45
	180	105	19-22		
	220	130	22-25		
	260	140	24-27		
	300	165	26-29	5/8-3/4	40-50
	340	175	27-31		
	380	185	28-32		
	420	195	28-33		
	460	205	28-34		
	500	215	28-34		

Table shown is approximate values that will vary with change in welding conditions. DC-Electrode positive. For 75% Ar + 25% CO₂, two (2) volts lower than shown.

Minimum applicable base metal thickness (gauge)

Butt joint	Horizontal fillet	Lap joint
> 16	> 14	> 16

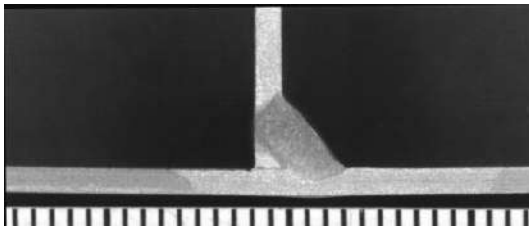

Plate thickness: 16 gauge (0.06")
 Welding wire: DW-G308L
 Welding position: Horizontal fillet
 Welding condition: 100A-20V-16 ipm 100% CO₂

Features

- 1. Excellent arc transfer with lower amperage**
 DWG 0.045" can be used instead of 0.035" FCW, solid wire or covered electrode.
- 2. Higher deposition rate**
 Unique wire structure assures 10-15% higher deposition than regular FCW.
- 3. Failure-free arc ignition**
 Re-ignition without clipping off wire end.
- 4. Versatility**
 Applicable shielding gas: 100% CO₂ or 75-80% Ar-balanced CO₂.

Stainless Steel Flux Cored TIG Rod (TG-X Series)

- No back shielding purge is necessary for root pass in pipe joint -

Recommended Welding Condition and Groove Preparation

Rod Diameter (in.)	Plate Thickness (in.)	Root Gap (in.)	Current (A)	Shielding Gas
0.087	1/8-3/16	5/64	80-90	100% Ar
	1/4-11/16	3/32	90-105	
	3/8-	7/64	90-110	

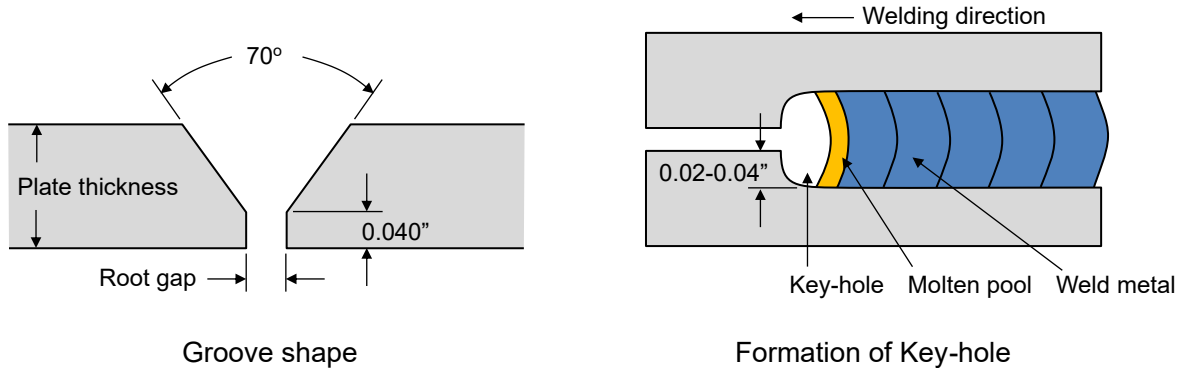

Comparison of TGX to Conventional Solid Filler Rod

Requirements		Filler Rod					
		TGX	Conventional		TGX	Conventional	
Pipe Dia. (in.)		2	2		12	12	
Root Gap (in.)		5/64	1/16		7/64	3/32	
Back Shielding Method		-	Local (12 in.)	Entire (236 in.)	-	Local (12 in.)	Entire (236 in.)
Time (minute)	Pre-purging	-	0.2	4.0	-	5.2	104.0
	Setting of jigs	-	10.0	-	-	10.0	-
	Welding	6.0	5.2	5.2	35.0	30.0	30.0
	Total	6.0	15.4	9.2	35.0	45.2	134.0
Amount of Gas (CFH)	Pre-purging	-	0.2	3.3	-	4.3	86.3
	Back Shielding	-	1.5	1.5	-	8.5	8.5
	Shielding in Welding	1.6	1.4	1.4	9.3	7.9	7.9
	Total	1.6	3.1	6.2	9.3	20.7	102.7

Back shielding condition refers to AWS D10.12.

Welding time contains time for tack welding and grinding. Arc time ratio is 50 %.

Gas flow rate: Pre-purging 50 CFH, Back shielding 17 CFH, Shielding in welding 32 CFH.

Carbon Steel Flux Cored Wire

Recommended Welding Parameters (Shielding gas: 100% CO₂)

Wire Diameter (in.)	Wire Feed Speed (in./min.)	Welding Current (A)	Arc Voltage (V)	Deposition Rate (lbs/hr)	CTWD (in.)	Shielding Gas Flow Rate (CFH)
0.045	160	120	22-25	3.5	3/4	40-50
	205	140	23-26	4.5		
	250	160	24-27	5.5		
	295	180	25-28	6.5		
	340	200	26-29	7.5		
	385	220	27-30	8.5		
	430	240	28-31	9.5		
	450	250	29-32	10.0		
0.052	120	140	24-27	3.5	3/4-1	40-50
	145	160	24-27	4.5		
	175	180	24-27	5.5		
	205	200	25-28	6.5		
	235	220	26-29	7.5		
	265	240	27-30	8.5		
	300	260	28-31	9.5		
	345	280	29-32	10.5		
	395	300	30-33	11.5		
1/16	100	180	24-27	4.5	3/4-1	40-50
	120	200	25-28	5.5		
	140	220	25-28	6.0		
	165	240	25-28	7.0		
	190	260	26-29	8.0		
	215	280	27-30	9.0		
	240	300	28-31	10.0		
	270	320	29-32	10.5		
	300	340	30-34	11.5		

Table shown is approximate values that will vary with change in welding conditions.

DC-Electrode positive.

Gas flow rate is measured at the torch nozzle

For 75% Ar + 25% CO₂, two (2) volts lower than shown.

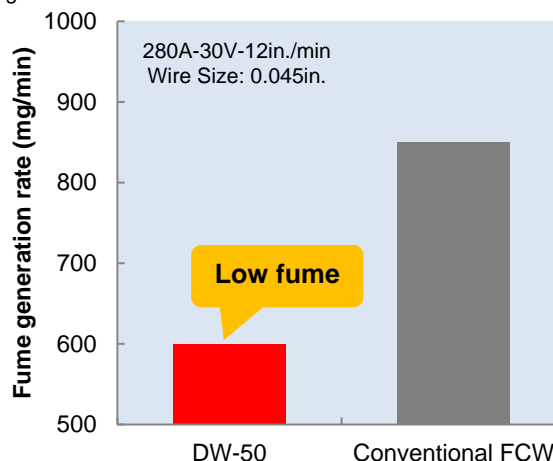

Carbon Steel Metal Cored Wire

Recommended Welding Parameters (Shielding gas: 75% Ar + 25% CO₂)

Wire Diameter (in.)	Wire Feed Speed (in./min.)	Welding Current (A)	Arc Voltage (V)	Deposition Rate (lbs/hr)	CTWD (in.)	Shielding Gas Flow Rate (CFH)
0.045	300	200	28-31	7.5	5/8-3/4	40-50
	375	240	29-33	9.5		
	435	280	30-34	11.0		
	530	320	32-36	13.5		
0.052	250	230	27-29	8.5	3/4-1	40-50
	300	270	28-32	10.5		
	400	320	30-34	14.0		
	460	370	31-36	16.0		
1/16	165	260	27-29	7.5	3/4-1	40-50
	245	320	28-33	11.5		
	350	380	29-35	17.0		
	415	440	30-36	20.0		

Table shown is approximate values that will vary with change in welding conditions.

DC-Electrode positive.

Gas flow rate is measured at the torch nozzle.

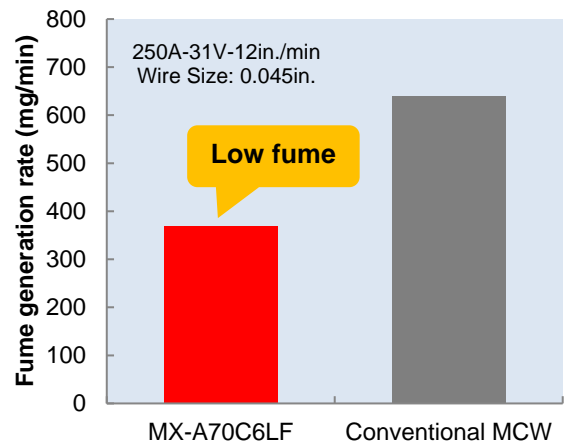
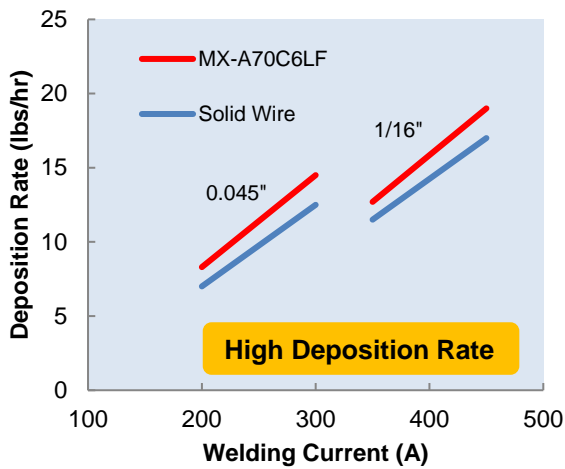

Carbon Steel Solid Wire

Recommended Welding Parameters (Shielding gas: 75% Ar + 25% CO₂)

Wire Diameter (in.)	Wire Feed Speed (in./min.)	Welding Current (A)	Arc Voltage (V)	Deposition Rate (lbs/hr)	CTWD (in.)	Shielding Gas Flow Rate (CFH)
0.035	75	60	14-15	1.2	3/8-5/8	35-45
	110	80	15-16	1.8		
	150	100	16-17	2.4		
	190	120	17-18	3.0		
	235	140	18-19	3.7		
0.045	105	100	17-19	3.4	5/8-3/4	40-50
	125	120	18-19	4.0		
	155	140	19-20	4.6		
	190	160	20-21	5.2		
	225	180	21-22	6.4		
	260	200	22-23	7.0		
	300	220	24-25	7.4		
	335	240	26-27	7.8		
	370	260	28-29	8.5		
	415	280	29-30	9.4		
455	300	30-31	10.5			

Table shown is approximate values that will vary with change in welding conditions.

DC-Electrode positive.

Gas flow rate is measured at the torch nozzle.

Brand Names

All Kobelco welding consumables are designated with “Trade Designation” and are grouped into the following three groups on the basis of the characteristics of individual products as detailed below.

(1) **FAMILIARC™** (Famili-Arc)

A coined word produced by combining “Familiar” and “Arc”.

Welding consumables grouped into this group are used for general welded structures made of mild steels and high tensile strength steels that have the tensile strength of less than 80 ksi.

(2) **TRUSTARC™** (Trust-Arc)

A coined word produced by combining “Trust” and “Arc”.

Welding consumables grouped into this group are used for such steels that require highly credible qualities as high tensile strength steel with the tensile strength of 80 ksi and higher, low temperature service steels, and heat-resistant low-alloy steels.

(3) **PREMIARC™** (Premi- Arc)

A coined word produced by combining “Premium” and “Arc”.

Welding consumables grouped into this group are used for high-alloy steels, stainless steels, and nonferrous metals.

Notification

Please note, Kobelco welding business is updating the warning label on its product packages for all welding consumables to be sold in the State of California to comply with the California proposition 65 (“Prop” 65) which requires its manufacturers and sellers to notify California consumers of chemicals in their products that we are known to the State of California to cause cancer or other harm, manely birth defects and reproductive defects, effective August 30, 2018

(to learn more, visit http://www.oehha.ca.gov/prop65/prop65_list/newlist.html).

All products on this catalog except Familiarc™ MG-51T (appears on page 9 and 26) will be delivered with the warning label below after August 30 2018, effective date in the State of California. Familiarc™ MG-51T does not contain any trace of notification for consumers so it does not have the warning label.

Warning Label for the State of California:



WARNING: This product can expose you to chemicals including Nickel and Titanium Dioxide, which are known to the State of California to cause cancer, and Chromium, which is known to the State of California to cause cancer and birth defects or other reproductive harm. For more information go to www.P65Warnings.ca.gov.

A guide for Selecting Welding Consumables

Steel Type	Key note for Application	FCAW
304	General	DW-308P
	High temperature service and solution treatment	DW-308H
304L	Low carbon (0.04% maximum)	DW-308L DW-308LP
304H	High temperatures	DW-308H
Dissimilar metals	General	DW-309L DW-309LP DW-309LMo DW-309LMoP DW-312
316	General	DW-316
316L	Low carbon (0.04% maximum)	DW-316L DW-316LP
	Cryogenic temperature	DW-316LT
316H	High temperatures	DW-316H
317L	Low carbon (0.04% maximum)	DW-317L DW-317LP
347	General	DW-347
	High temperatures	DW-347H
321	General	DW-347
	High temperatures	DW-347H
310S	General	DW-310
S32101 S32304 S32003	Lean duplex (22%Cr-Low Ni-N, PREN: 30 maximum)	DW-2209 DW-329AP
S31803 S32205	Standard duplex (22%Cr-5%Ni-3%Mo-N, PREN: approx. 35)	DW-2209 DW-329AP DW-2594
S32750 S32760 S32560	Super duplex (25%Cr-7%Ni-4%Mo-N, PREN: 45 minimum)	DW-2594

Stainless Steel Flux Cored Wire

PREMIARC™

DW-308L AWS A5.22 E308LT0-1/4

Diameters: 0.045", 1/16", Spool size: 28 lbs

C	Mn	Si	Cr	Ni	FN (WRC)	YS (ksi)	TS (ksi)	EI (%)
0.03	1.57	0.68	19.2	10.3	7	61	79	42

Shielding gas: 100%CO₂ or 75-80% Ar / bal. CO₂

Approvals: ABS, LR, DNV-GL, CWB



PREMIARC™

DW-308LP AWS A5.22 E308LT1-1/4

Diameters: 0.035", 0.045", 1/16", Spool size: 28 lbs

C	Mn	Si	Cr	Ni	FN (WRC)	YS (ksi)	TS (ksi)	EI (%)
0.02	1.34	0.63	19.0	10.3	7	59	78	42

Shielding gas: 100%CO₂ or 75-80% Ar / bal. CO₂

Approvals: ABS, LR, DNV-GL, CWB



PREMIARC™

DW-308P AWS A5.22 E308T1-1/4

Diameter: 0.045", Spool size: 28 lbs

C	Mn	Si	Cr	Ni	FN (WRC)	YS (ksi)	TS (ksi)	EI (%)
0.06	1.25	0.57	19.4	9.6	6	55	83	42

Shielding gas: 100%CO₂ or 75-80% Ar / bal. CO₂

Approvals: -



PREMIARC™

DW-308H AWS A5.22 E308HT1-1/4

Diameters: 0.045", Spool size: 28 lbs

C	Mn	Si	Cr	Ni	Bi	FN (WRC)	YS (ksi)	TS (ksi)	EI (%)
0.06	1.32	0.49	18.8	9.5	<0.001	4	57	82	42

Shielding gas: 100%CO₂ or 75-80% Ar / bal. CO₂

Approvals: CWB



PREMIARC™

DW-309L AWS A5.22 E309LT0-1/4

Diameters: 0.045", 1/16", Spool size: 28 lbs

C	Mn	Si	Cr	Ni	FN (WRC)	YS (ksi)	TS (ksi)	EI (%)
0.03	1.18	0.69	23.7	12.4	19	61	81	34

Shielding gas: 100%CO₂ or 75-80% Ar / bal. CO₂

Approvals: ABS, LR, DNV-GL, CWB



PREMIARC™

DW-309LP AWS A5.22 E309LT1-1/4

Diameters: 0.035", 0.045", 1/16", Spool size: 28 lbs

C	Mn	Si	Cr	Ni	FN (WRC)	YS (ksi)	TS (ksi)	EI (%)
0.02	0.82	0.86	23.3	12.6	18	59	79	42

Shielding gas: 100%CO₂ or 75-80% Ar / bal. CO₂

Approvals: ABS, LR, DNV-GL, CWB



PREMIARC™**DW-309LMo** AWS A5.22 E309LMoT0-1/4 Diameters: 0.045", 1/16", Spool size: 28 lbs

C	Mn	Si	Cr	Ni	Mo	FN (WRC)	YS (ksi)	TS (ksi)	EI (%)
0.03	1.52	0.76	23.2	12.3	2.4	29	71	106	33

Shielding gas: 100%CO₂ or 75-80% Ar / bal. CO₂

Approvals: CWB

**PREMIARC™****DW-309LMoP** AWS A5.22 E309LMoT1-1/4 Diameter: 0.045", Spool size: 28 lbs

C	Mn	Si	Cr	Ni	Mo	FN (WRC)	YS (ksi)	TS (ksi)	EI (%)
0.03	0.65	0.41	22.4	12.5	2.2	18	59	79	42

Shielding gas: 100%CO₂ or 75-80% Ar / bal. CO₂

Approvals: -

**PREMIARC™****DW-310** AWS A5.22 E310T0-1/4 Diameter: 0.045", Spool size: 28 lbs

C	Mn	Si	Cr	Ni	Bi	FN (WRC)	YS (ksi)	TS (ksi)	EI (%)
0.18	2.10	0.58	25.5	20.4	<0.001	<1	63	92	34

Shielding gas: 100%CO₂ or 75-80% Ar / bal. CO₂

Approvals: CWB

**PREMIARC™****DW-312** AWS A5.22 E312T0-1/4 Diameter: 0.045", Spool size: 28 lbs

C	Mn	Si	Cr	Ni	FN (WRC)	YS (ksi)	TS (ksi)	EI (%)
0.11	1.88	0.68	28.6	10.3	48	79	113	24

Shielding gas: 100%CO₂

Approvals: CWB

**PREMIARC™****DW-316L** AWS A5.22 E316LT0-1/4 Diameters: 0.045", 1/16", Spool size: 28 lbs

C	Mn	Si	Cr	Ni	Mo	FN (WRC)	YS (ksi)	TS (ksi)	EI (%)
0.03	1.46	0.76	18.4	12.1	2.3	6	58	82	37

Shielding gas: 100%CO₂ or 75-80% Ar / bal. CO₂

Approvals: ABS, LR, DNV-GL, CWB

**PREMIARC™****DW-316LP** AWS A5.22 E316LT1-1/4 Diameters: 0.035", 0.045", 1/16", Spool size: 28 lbs

C	Mn	Si	Cr	Ni	Mo	FN (WRC)	YS (ksi)	TS (ksi)	EI (%)
0.02	1.27	0.74	18.2	12.1	2.8	8	60	82	36

Shielding gas: 100%CO₂ or 75-80% Ar / bal. CO₂

Approvals: LR, DNV-GL, CWB



PREMIARC™**DW-316H** AWS A5.22 E316T1-1/4

Diameter: 0.045", Spool size: 28 lbs

C	Mn	Si	Cr	Ni	Mo	Bi	FN (WRC)	YS (ksi)	TS (ksi)	EI (%)
0.06	1.16	0.52	19.0	11.5	2.3	<0.001	7	57	83	41

Shielding gas: 100%CO₂ or 75-80% Ar / bal. CO₂

Approvals: -

**PREMIARC™****DW-316LT** AWS A5.22 E316LT1-1/4

Diameter: 0.045", Spool size: 28 lbs

C	Mn	Si	Cr	Ni	Mo	FN (WRC)	IV@- 320°F (ft-lbf)	YS (ksi)	TS (ksi)	EI (%)
0.02	1.60	0.35	17.6	11.9	2.3	5	27	58	77	44

Shielding gas: 100%CO₂ or 75-80% Ar / bal. CO₂

Approvals: ABS, LR, DNV-GL

**PREMIARC™****DW-317L** AWS A5.22 E317LT0-1/4

Diameters: 0.045", 1/16", Spool size: 28 lbs

C	Mn	Si	Cr	Ni	Mo	FN (WRC)	YS (ksi)	TS (ksi)	EI (%)
0.02	1.03	0.43	19.0	12.7	3.2	6	60	89	36

Shielding gas: 100%CO₂ or 75-80% Ar / bal. CO₂

Approvals: CWB

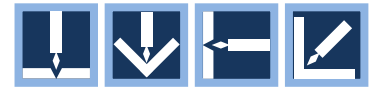
**PREMIARC™****DW-317LP** AWS A5.22 E317LT1-1/4

Diameter: 0.045", Spool size: 28 lbs

C	Mn	Si	Cr	Ni	Mo	FN (WRC)	YS (ksi)	TS (ksi)	EI (%)
0.03	1.33	0.63	18.7	13.8	3.4	6	63	84	37

Shielding gas: 100%CO₂ or 75-80% Ar / bal. CO₂

Approvals: -

**PREMIARC™****DW-347** AWS A5.22 E347T0-1/4

Diameters: 0.045", 1/16", Spool size: 28 lbs

C	Mn	Si	Cr	Ni	Nb	FN (WRC)	YS (ksi)	TS (ksi)	EI (%)
0.05	1.50	0.36	19.0	9.8	0.59	7	62	81	37

Shielding gas: 100%CO₂ or 75-80% Ar / bal. CO₂

Approvals: CWB

**PREMIARC™****DW-347H** AWS A5.22 E347T1-1/4

Diameter: 0.045", Spool size: 28 lbs

C	Mn	Si	Cr	Ni	Nb	Bi	FN (WRC)	YS (ksi)	TS (ksi)	EI (%)
0.06	1.52	0.51	19.1	9.4	0.72	<0.001	7	67	96	39

Shielding gas: 100%CO₂ or 75-80% Ar / bal. CO₂

Approvals: -



PREMIARC™

DW-A904L EN ISO 17633-A- T 20 25 5 Cu N LP M21 2 Diameter: 0.045", Spool size: 28 lbs

C	Mn	Si	Cu	Cr	Ni	Mo	N	YS (ksi)	TS (ksi)	EI (%)
0.03	1.56	0.66	1.34	20.9	25.3	4.8	0.13	61	96	36

Shielding gas: 75-80% Ar / bal. CO₂

Approvals: -



For Gauge Materials - DWG Series -

PREMIARC™

For Gauge Materials

DW-G308L AWS A5.22 E308LT0-1/4 Diameter: 0.045", Spool size: 28 lbs

C	Mn	Si	Cr	Ni	FN (WRC)	YS (ksi)	TS (ksi)	EI (%)
0.02	1.11	0.78	19.5	9.9	10	54	80	43

Shielding gas: 100%CO₂ or 75-80% Ar / bal. CO₂

Approvals: CWB



PREMIARC™

For Gauge Materials

DW-G309L AWS A5.22 E309LT0-1/4 Diameter: 0.045", Spool size: 28 lbs

C	Mn	Si	Cr	Ni	FN (WRC)	YS (ksi)	TS (ksi)	EI (%)
0.03	1.21	0.68	24.1	12.5	22	65	83	37

Shielding gas: 100%CO₂ or 75-80% Ar / bal. CO₂

Approvals: CWB



PREMIARC™

For Gauge Materials

DW-G316L AWS A5.22 E316LT0-1/4 Diameter: 0.045", Spool size: 28 lbs

C	Mn	Si	Cr	Ni	Mo	FN (WRC)	YS (ksi)	TS (ksi)	EI (%)
0.02	1.13	0.75	18.8	12.8	2.3	6	60	82	36

Shielding gas: 100%CO₂ or 75-80% Ar / bal. CO₂

Approvals: CWB



Reduced Hexavalent Cr Production - XR Series -

PREMIARC™

DW-308L-XR AWS A5.22 E308LT0-1/4 Diameter: 0.045", Spool size: 28 lbs

C	Mn	Si	Cr	Ni	FN (WRC)	YS (ksi)	TS (ksi)	EI (%)
0.03	1.29	0.74	19.4	9.5	11	57	85	40

Shielding gas: 100%CO₂ or 75-80% Ar / bal. CO₂

Approvals: CWB



PREMIARC™

DW-309L-XR AWS A5.22 E309LT0-1/4

Diameter: 0.045", Spool size: 28 lbs

C	Mn	Si	Cr	Ni	FN (WRC)	YS (ksi)	TS (ksi)	EI (%)
0.03	1.36	0.82	24.4	12.1	23	69	94	33

Shielding gas: 100%CO₂ or 75-80% Ar / bal. CO₂

Approvals: CWB



PREMIARC™

DW-316L-XR AWS A5.22 E316LT0-1/4

Diameter: 0.045", Spool size: 28 lbs

C	Mn	Si	Cr	Ni	Mo	FN (WRC)	YS (ksi)	TS (ksi)	EI (%)
0.03	1.28	0.74	18.9	12.0	2.4	9	58	80	42

Shielding gas: 100%CO₂ or 75-80% Ar / bal. CO₂

Approvals: CWB



PREMIARC™

DW-308LP-XR AWS A5.22 E308LT1-1/4

Diameter: 0.045", Spool size: 28 lbs

C	Mn	Si	Cr	Ni	FN (WRC)	YS (ksi)	TS (ksi)	EI (%)
0.02	1.58	0.74	18.9	10.2	7	53	78	43

Shielding gas: 100%CO₂ or 75-80% Ar / bal. CO₂

Approvals: ABS, CWB



PREMIARC™

DW-309LP-XR AWS A5.22 E309LT1-1/4

Diameter: 0.045", Spool size: 28 lbs

C	Mn	Si	Cr	Ni	FN (WRC)	YS (ksi)	TS (ksi)	EI (%)
0.03	0.75	0.57	23.4	12.3	18	60	79	36

Shielding gas: 100%CO₂ or 75-80% Ar / bal. CO₂

Approvals: ABS, CWB



PREMIARC™

DW-316LP-XR AWS A5.22 E316LT1-1/4

Diameter: 0.045", Spool size: 28 lbs

C	Mn	Si	Cr	Ni	Mo	FN (WRC)	YS (ksi)	TS (ksi)	EI (%)
0.02	1.03	0.70	18.5	12.5	2.8	8	59	79	43

Shielding gas: 100%CO₂ or 75-80% Ar / bal. CO₂

Approvals: ABS, CWB



Flux Cored Wire for Duplex Stainless Steel

PREMIARC™

For Standard Duplex Stainless Steel, with Excellent Toughness for -40F Application

DW-2209

AWS A5.22 E2209T1-1/4

Diameter: 0.045", Spool size: 28 lbs

C	Mn	Si	Cr	Ni	Mo	N	FN (WRC)	YS (ksi)	TS (ksi)	EI (%)
0.02	0.89	0.55	23.0	9.7	3.3	0.14	41	90	117	31

Shielding gas: 100%CO₂ or 75-80% Ar / bal. CO₂

Approvals: LR, CWB



PREMIARC™

For Standard Duplex Stainless Steel, with Excellent Weldability in Vertical Position

DW-329AP

AWS A5.22 E2209T1-1/4

Diameter: 0.045", Spool size: 28 lbs

C	Mn	Si	Cr	Ni	Mo	N	FN (WRC)	YS (ksi)	TS (ksi)	EI (%)
0.02	0.76	0.68	23.3	9.4	3.4	0.14	49	88	119	30

Shielding gas: 100%CO₂ or 75-80% Ar / bal. CO₂

Approvals: ABS, LR, DNV-GL, CWB



PREMIARC™

For Super Duplex Stainless Steel

DW-2594

AWS A5.22 E2594T1-1/4

Diameter: 0.045", Spool size: 28 lbs

C	Mn	Si	Cr	Ni	Mo	N	FN (WRC)	YS (ksi)	TS (ksi)	EI (%)
0.03	1.18	0.50	25.7	9.6	3.8	0.24	49	103	131	27

Shielding gas: 100%CO₂ or 75-80% Ar / bal. CO₂

Approvals: ABS, LR, DNV-GL, CWB



Flux Cored TIG Rod - TGX Series -

PREMIARC™

No back purge necessary

TG-X308L

AWS A5.22 R308LT1-5

Diameter: 0.087", Packaging: 11 lbs

C	Mn	Si	Cr	Ni	FN (WRC)	YS (ksi)	TS (ksi)	EI (%)
0.01	1.46	0.70	19.2	10.2	10	65	93	47

Shielding gas: 100%Ar

Approvals: -

PREMIARC™

No back purge necessary

TG-X309L

AWS A5.22 R309LT1-5

Diameter: 0.087", Packaging: 11 lbs

C	Mn	Si	Cr	Ni	FN (WRC)	YS (ksi)	TS (ksi)	EI (%)
0.02	1.58	0.74	23.9	12.7	21	77	99	32

Shielding gas: 100%Ar

Approvals: -

PREMIARC™

No back purge necessary

TG-X316L

AWS A5.22 R316LT1-5

Diameter: 0.087", Packaging: 11 lbs

C	Mn	Si	Cr	Ni	Mo	FN (WRC)	YS (ksi)	TS (ksi)	EI (%)
0.02	1.55	0.87	19.0	12.5	2.3	7	64	87	38

Shielding gas: 100%Ar

Approvals: -

PREMIARC™

No back purge necessary

TG-X347

AWS A5.22 R347T1-5

Diameter: 0.087", Packaging: 11 lbs

C	Mn	Si	Cr	Ni	Nb	FN (WRC)	YS (ksi)	TS (ksi)	EI (%)
0.02	1.60	0.80	19.9	10.2	0.68	9	67	91	48

Shielding gas: 100%Ar

Approvals: -

PREMIARC™

No back purge necessary

TG-X2209

AWS -

Diameter: 0.087", Packaging: 11 lbs

C	Mn	Si	Cr	Ni	Mo	N	FN (WRC)	YS (ksi)	TS (ksi)	EI (%)
0.02	0.87	0.64	23.1	9.5	3.3	0.15	47	88	118	32

Shielding gas: 100%Ar

Approvals: -

Nickel Based Alloy Flux Cored Wire

PREMIARC™

DW-N625

AWS A5.34 ENiCrMo3T1-4

Diameter: 0.045", Spool size: 28 lbs

C	Mn	Si	Cr	Ni	Mo	Nb+Ta	IV@-320°F (ft-lbf)	TS (ksi)	EI (%)
0.03	0.29	0.37	21.7	63.3	8.4	3.7	38	114	41

Shielding gas: 75-80% Ar / bal. CO₂

Approvals: ABS



PREMIARC™

DW-NC276

AWS A5.34 ENiCrMo4T1-4

Diameter: 0.045", Spool size: 28 lbs

C	Mn	Si	Cr	Ni	Mo	W	IV@-320°F (ft-lbf)	TS (ksi)	EI (%)
0.02	0.80	0.20	15.7	58.0	16.1	3.5	39	105	48

Shielding gas: 75-80% Ar / bal. CO₂

Approvals: -



PREMIARC™

DW-N82

AWS A5.34 ENiCr3T1-4

Diameter: 0.045", Spool size: 28 lbs

C	Mn	Si	Cr	Ni	Ti	Nb+Ta	IV@-320°F (ft-lbf)	TS (ksi)	EI (%)
0.02	3.00	0.20	21.1	71.4	0.17	2.5	92	96	44

Shielding gas: 75-80% Ar / bal. CO₂

Approvals: -



Carbon Steel Flux Cored Wire

FRONTIARC-711 AWS A5.20 E71T-1C/1M H8 Diameters: 0.045", 0.052", 1/16"
 AWS A5.20 E71T-12C/12M H8 Spool: 28 lbs, 44 lbs, Drum: 550 lbs

C	Mn	Si	P	S	IV@-20°F (ft-lbf)	YS (ksi)	TS (ksi)	EI (%)
0.04	1.32	0.56	0.012	0.009	54	76	86	31

Shielding gas: 100%CO₂ or 75-80% Ar / bal. CO₂

Approvals: ABS, LR, CWB, AWS D1.8



Fast freezing slag system

FAMILIARC™ DW-50 AWS A5.20 E71T-1C/1M H8 Diameters: 0.045", 0.052", 1/16"
 AWS A5.20 E71T-9C/9M H8 Spool: 15lbs, 28 lbs, 44 lbs, Drum: 550 lbs

C	Mn	Si	P	S	IV@-20°F (ft-lbf)	YS (ksi)	TS (ksi)	EI (%)
0.05	1.52	0.71	0.011	0.009	43	81	89	28

Shielding gas: 100%CO₂ or 75-80% Ar / bal. CO₂

Approvals: ABS, LR, DNV-GL, CWB, AWS D1.8



FAMILIARC™ DW-50AY *Large diameter, High deposition rate*

AWS A5.20 E70T-1C/9C H8 Diameter: 3/32", Coil size: 50lbs

C	Mn	Si	P	S	IV@-20°F (ft-lbf)	YS (ksi)	TS (ksi)	EI (%)
0.06	1.52	0.37	0.011	0.005	94	70	81	32

Shielding gas: 100%CO₂

Approvals: AWS D1.8



FAMILIARC™ DW-A55EH AWS A5.20 E71T-12M-J H8 Diameters: 0.045", 1/16", Spool size: 44 lbs

C	Mn	Si	P	S	Ni	IV@-50°F (ft-lbf)	YS (ksi)	TS (ksi)	EI (%)
0.05	1.17	0.63	0.010	0.007	0.38	93	81	88	30

Shielding gas: 75-80% Ar / bal. CO₂

Approvals: ABS, CWB



FAMILIARC™ DW-A55ESR *Suitable for PWHT conditions*

AWS A5.20 E71T-12M-J Diameters: 0.045", 1/16", Spool size: 44 lbs

C	Mn	Si	P	S	Ni	IV@-51°F (ft-lbf)	YS (ksi)	TS (ksi)	EI (%)
0.05	1.36	0.47	0.011	0.007	0.43	100	76	85	29

Shielding gas: 75-80% Ar / bal. CO₂

Approvals: ABS, CWB



Carbon Steel Hybrid Flux Cored Wire

FAMILIARC™

Suitable for robotic welding for structural steel

MX-50R

AWS A5.20 E70T-1C

Diameter: 0.052" Spool: 44 lbs, Drum: 550 lbs

C	Mn	Si	P	S	IV@0°F (ft-lbf)	YS (ksi)	TS (ksi)	EI (%)
0.04	1.60	0.57	0.008	0.006	66	65	78	32

Shielding gas: 100% CO₂

Approvals: AWS D1.8



Carbon Steel Metal Cored Wire

FAMILIARC™

MX-A70C6LF

AWS A5.18 E70C-6M

Diameters: 0.045", 0.052", 1/16"

Spool: 44 lbs, Drum: 550 lbs

C	Mn	Si	P	S	IV@-20°F (ft-lbf)	YS (ksi)	TS (ksi)	EI (%)
0.03	1.70	0.85	0.008	0.010	64	65	80	31

Shielding gas: 75-95% Ar / bal. CO₂

Approvals: CWB



Carbon Steel Solid Wire

FAMILIARC™

MG-51T

AWS A5.18 ER70S-6

Diameter: 0.035", 0.045", Spool: 44 lbs, Drum: 660 lbs

C	Mn	Si	P	S	Cu	IV@-20°F (ft-lbf)	YS (ksi)	TS (ksi)	EI (%)
0.10	1.56	0.88	0.011	0.012	0.24	66	75	87	31

Shielding gas: 100%CO₂ or 75-80% Ar / bal. CO₂

Approvals: -



Low Alloy Steel Flux Cored Wire

TRUSTARC™

DW-81B2

AWS A5.29 E81T1-B2M

Diameters: 0.045", 1/16", Spool size: 28 lbs

C	Mn	Si	P	S	Cr	Mo	YS (ksi)	TS (ksi)	EI (%)
0.06	1.07	0.33	0.008	0.006	1.24	0.46	81	93	25

Shielding gas: 75-80% Ar / bal. CO₂

Approvals: CWB



TRUSTARC™

DW-91B3

AWS A5.29 E91T1-B3M

Diameters: 0.045", 1/16", Spool size: 28 lbs

C	Mn	Si	P	S	Cr	Mo	YS (ksi)	TS (ksi)	EI (%)
0.06	1.08	0.31	0.006	0.007	2.23	0.95	85	98	20

Shielding gas: 75-80% Ar / bal. CO₂

Approvals: CWB



TRUSTARC™

Suitable for PWHT conditions

DW-A55LSR

AWS A5.29 E81T1-Ni1M

Diameter: 0.045", Spool size: 28 lbs

C	Mn	Si	P	S	Ni	IV@-76°F (ft-lbf)	YS (ksi)	TS (ksi)	EI (%)
0.05	1.32	0.33	0.009	0.008	0.90	89	74	83	29

Shielding gas: 75-80% Ar / bal. CO₂

Approvals: ABS, LR, DNV-GL, CWB



TRUSTARC™

DW-A81Ni1

AWS A5.29 E81T1-Ni1MJ

Diameter: 0.045", Spool size: 28 lbs

C	Mn	Si	P	S	Ni	IV@-76°F (ft-lbf)	YS (ksi)	TS (ksi)	EI (%)
0.05	1.32	0.36	0.006	0.006	0.99	60	78	87	31

Shielding gas: 75-80% Ar / bal. CO₂

Approvals: ABS, LR, DNV-GL, CWB



TRUSTARC™

110 ksi tensile strength

DW-A80L

AWS A5.29 E111T1-GM H4

Diameter: 0.045", Spool size: 28 lbs

C	Mn	Si	P	S	Ni	Mo	IV@-76°F (ft-lbf)	YS (ksi)	TS (ksi)	EI (%)
0.07	1.86	0.31	0.007	0.006	2.49	0.16	60	111	118	21

Shielding gas: 75-80% Ar / bal. CO₂

Approvals: ABS, LR, DNV-GL



Low Alloy Steel Flux Cored Wire

Available Approvals

Available Approvals

Product Name	Shielding Gas	AWS / ASME		ASME		CWB	ABS	LR	DNVGL	D1.8
		A5.22	E	F#	A#					
DW-308L	Ar+CO ₂	A5.22	E308LT0-4	6	8	✓				
	CO ₂	A5.22	E308LT0-1	6	8	✓	✓	✓	✓	
DW-308LP	Ar+CO ₂	A5.22	E308LT1-4	6	8	✓				
	CO ₂	A5.22	E308LT1-1	6	8	✓	✓	✓	✓	
DW-308P	Ar+CO ₂	A5.22	E308T1-4	6	8					
	CO ₂	A5.22	E308T1-1	6	8					
DW-308H	Ar+CO ₂	A5.22	E308HT1-4	6	8	✓				
	CO ₂	A5.22	E308HT1-1	6	8	✓				
DW-309L	Ar+CO ₂	A5.22	E309LT0-4	6	8	✓				
	CO ₂	A5.22	E309LT0-1	6	8	✓	✓	✓	✓	
DW-309LP	Ar+CO ₂	A5.22	E309LT1-4	6	8	✓	✓	✓	✓	
	CO ₂	A5.22	E309LT1-1	6	8	✓	✓	✓	✓	
DW-309LMo	Ar+CO ₂	A5.22	E309LMoT0-4	6	8	✓				
	CO ₂	A5.22	E309LMoT0-1	6	8	✓				
DW-309LMoP	Ar+CO ₂	A5.22	E309LMoT1-4	6	8					
	CO ₂	A5.22	E309LMoT1-1	6	8					
DW-316L	Ar+CO ₂	A5.22	E316LT0-4	6	8	✓		✓	✓	
	CO ₂	A5.22	E316LT0-1	6	8	✓	✓	✓	✓	
DW-316LP	Ar+CO ₂	A5.22	E316LT1-4	6	8	✓		✓	✓	
	CO ₂	A5.22	E316LT1-1	6	8	✓		✓	✓	
DW-316H	Ar+CO ₂	A5.22	E316T1-4	6	8					
	CO ₂	A5.22	E316T1-1	6	8					
DW-316LT	Ar+CO ₂	A5.22	E316LT1-4	6	8					
	CO ₂	A5.22	E316LT1-1	6	8		✓	✓	✓	
DW-347	Ar+CO ₂	A5.22	E347T0-4	6	8	✓				
	CO ₂	A5.22	E347T0-1	6	8	✓				
DW-347H	Ar+CO ₂	A5.22	E347T1-4	6	8					
	CO ₂	A5.22	E347T1-1	6	8					
DW-310	Ar+CO ₂	A5.22	E310T0-4	6	9	✓				
	CO ₂	A5.22	E310T0-1	6	9	✓				
DW-312	CO ₂	A5.22	E312T0-1	6	8	✓				
DW-317L	Ar+CO ₂	A5.22	E317LT0-4	6	8	✓				
	CO ₂	A5.22	E317LT0-1	6	8	✓				
DW-317LP	Ar+CO ₂	A5.22	E317LT1-4	6	8					
	CO ₂	A5.22	E317LT1-1	6	8					
DW-G308L	Ar+CO ₂	A5.22	E308LT0-4	6	8	✓				
	CO ₂	A5.22	E308LT0-1	6	8	✓				
DW-G309L	Ar+CO ₂	A5.22	E309LT0-4	6	8	✓				
	CO ₂	A5.22	E309LT0-1	6	8	✓				
DW-G316L	Ar+CO ₂	A5.22	E316LT0-4	6	8	✓				
	CO ₂	A5.22	E316LT0-1	6	8	✓				

AWS: American Welding Society

CWB Canadian Welding Bureau

ABS: American Bureau of Shipping

LR: Lloyd's Register of Shipping

D1.8: AWS D1.8 Seismic Structural Certification

	Product Name	Shielding Gas	AWS / ASME		ASME		CWB	ABS	LR	DNVGL	D1.8
					F#	A#					
Stainless Steel	DW-308L-XR	Ar+CO ₂	A5.22	E308LT0-4	6	8	✓				
		CO ₂	A5.22	E308LT0-1	6	8	✓				
	DW-308LP-XR	Ar+CO ₂	A5.22	E308LT1-4	6	8	✓	✓			
		CO ₂	A5.22	E308LT1-1	6	8	✓				
	DW-309L-XR	Ar+CO ₂	A5.22	E309LT0-4	6	8	✓				
		CO ₂	A5.22	E309LT0-1	6	8	✓				
	DW-309LP-XR	Ar+CO ₂	A5.22	E309LT1-4	6	8	✓	✓			
		CO ₂	A5.22	E309LT1-1	6	8	✓				
	DW-316L-XR	Ar+CO ₂	A5.22	E316LT0-4	6	8	✓				
		CO ₂	A5.22	E316LT0-1	6	8	✓				
	DW-316LP-XR	Ar+CO ₂	A5.22	E316LT1-4	6	8	✓	✓			
		CO ₂	A5.22	E316LT1-1	6	8	✓				
	DW-2209	Ar+CO ₂	A5.22	E2209T1-4	6	8	✓		✓		
		CO ₂	A5.22	E2209T1-1	6	8	✓				
	DW-329AP	Ar+CO ₂	A5.22	E2209T1-4	6	8	✓	✓	✓	✓	
CO ₂		A5.22	E2209T1-1	6	8	✓	✓	✓	✓		
DW-2594	Ar+CO ₂	A5.22	E2594T1-4	6	8	✓					
	CO ₂	A5.22	E2594T1-1	6	8	✓	✓	✓	✓		
TG-X308L	Ar	A5.22	R308LT1-5	6	8						
TG-X309L	Ar	A5.22	R309LT1-5	6	8						
TG-X316L	Ar	A5.22	R316LT1-5	6	8						
TG-X347	Ar	A5.22	R347T1-5	6	8						
TG-X2209	Ar										
Nickel Alloy	DW-N625	Ar+CO ₂	A5.34	ENiCrMo3T1-4	43	-					
	DW-NC276	Ar+CO ₂	A5.34	ENiCrMo4T1-4	43	-					
	DW-N82	Ar+CO ₂	A5.34	ENiCr3T0-4	43	-					
Carbon Steel	FRONTIARC-711	Ar+CO ₂	A5.20	E71T-1M/12M H8	6	1	✓	✓	✓		
		CO ₂	A5.20	E71T-1C/12C H8	6	1	✓	✓	✓		✓
	DW-50	Ar+CO ₂	A5.20	E71T-1M/9M H8	6	-	✓	✓	✓	✓	✓
		CO ₂	A5.20	E71T-1C/9C H8	6	-	✓	✓	✓	✓	✓
	DW-50AY	CO ₂	A5.20	E70T-1C/9C H8	6	-					✓
	DW-A55ESR	Ar+CO ₂	A5.20	E71T-12M-J	6	1	✓	✓			
	DW-A55EH	Ar+CO ₂	A5.20	E71T-12M-J H8	6	1	✓	✓			
MX-50R	CO ₂	A5.20	E70T-1C	6	-					✓	
MX-A70C6LF	Ar+CO ₂	A5.18	E70C-6M	6	-	✓					
Low Alloy Steel	DW-81B2	Ar+CO ₂	A5.29	E81T1-B2M	6	3	✓				
	DW-91B3	Ar+CO ₂	A5.29	E91T1-B3M	6	4	✓				
	DW-A55LSR	Ar+CO ₂	A5.29	E81T1-Ni1M	6	10	✓	✓	✓	✓	
	DW-A81Ni1	Ar+CO ₂	A5.29	E81T1-Ni1M-J	6	10	✓	✓	✓	✓	
	DW-A80L	Ar+CO ₂	A5.29	E111T1-GM H4	6	-		✓	✓	✓	

Welding positions

Butt welds

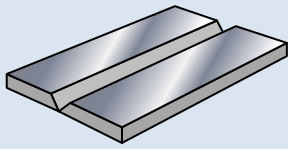

AWS: 1G

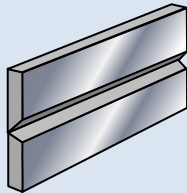

AWS: 2G

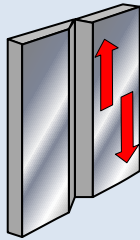

AWS: 3G

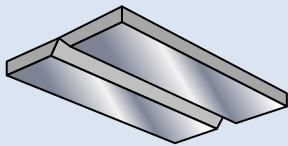

AWS: 4G

Fillet welds

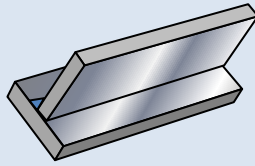

AWS: 1F

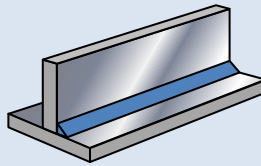

AWS: 2F

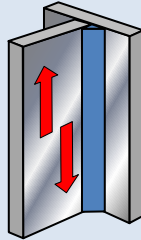

AWS: 3F

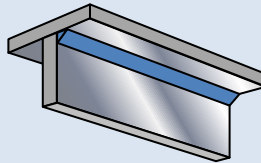

AWS: 4F

Pipe welds

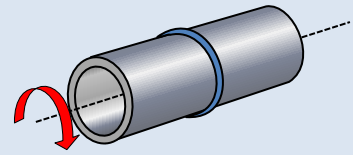

AWS: 1G

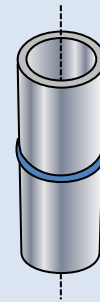

AWS: 2G

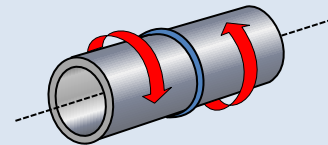

AWS: 5G

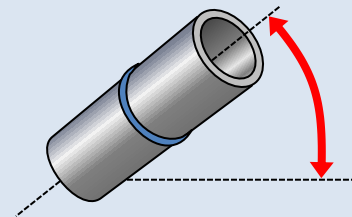

AWS: 6G

PREMIARC™

Stainless Steel Flux Cored Wire



FAMILIARC™

Carbon Steel Flux Cored Wire



TRUSTARC™

Low Alloy Steel Flux Cored Wire





KOBELCO

KOBELCO WELDING OF AMERICA, INC.

www.kobelcowelding.com

Head office:

4755 Alpine,
Suite 250,
Stafford, TX 77477 USA
Tel : 281-240-5600
Fax: 281-240-5625

Distribution Centers:



May. 2022

DISCLAIMER

- Information in this material, such as chemical compositions and mechanical properties, is typical or an example for explaining the features and performances of our products, and it does not mean guarantee unless otherwise it is specified.
- Information contained herein is subject to change without notice. Please kindly contact Kobelco for latest information.